

# MC 2500

## STEREO POWER AMPLIFIER

This service manual covers MC2500 units with serial numbers from CS2718 and above. Units with serial numbers from CS1001 to CS2717 are covered by schematics 039396 and 039397.

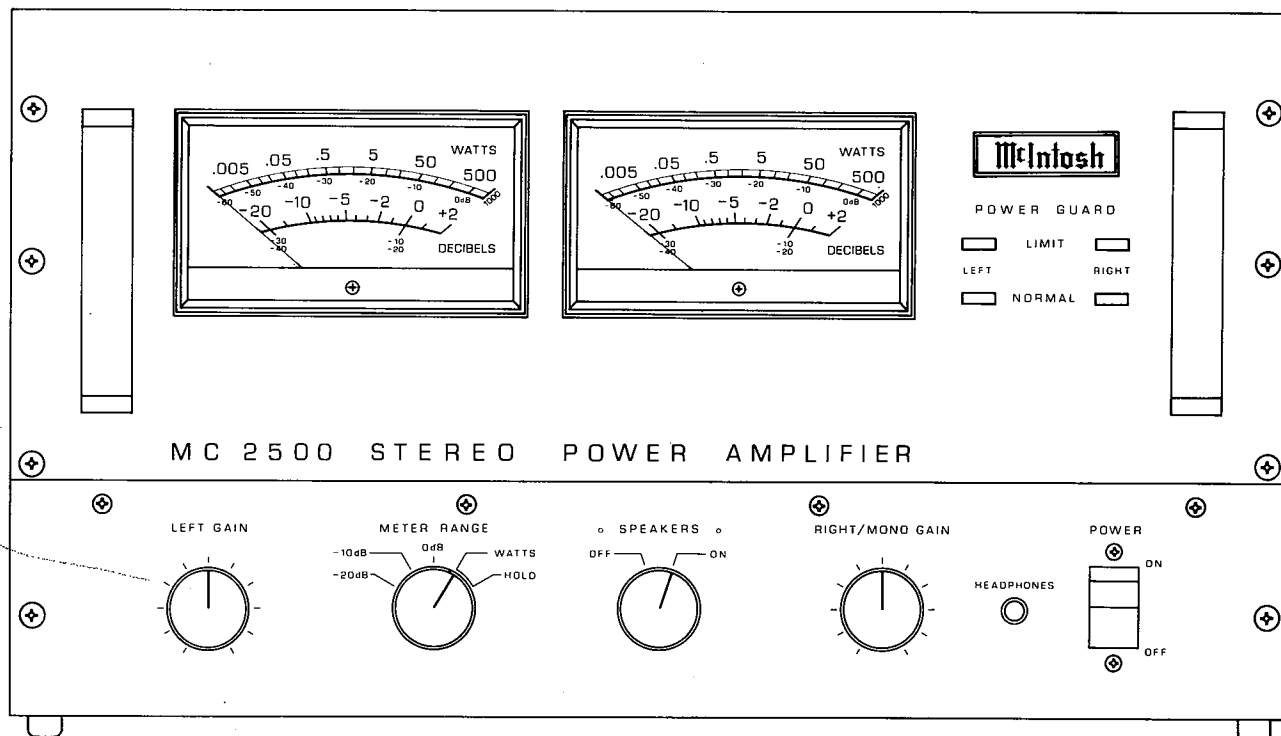

### CONTENTS

Performance Specifications.....	2
Mechanical Views.....	3-4
Notes.....	4
Section Locations.....	5
Block Diagram.....	6-7
Front Panel and Trim Parts List.....	8
Installation Parts List.....	8
Section 1—Interconnection Diagram.....	8-11
Section 2A—Amplifier (serial no. CS2718 to CS3999).....	12-15
Section 2B—Amplifier (serial no. CS4000 and above).....	16-19
Section 3—Meter Drive and Illumination.....	20-22
Section 4—Power Supply and Power Guard Display.....	23-24
Repacking Instructions.....	25

# Performance Specifications

## POWER OUTPUT

STEREO: 500 watts minimum sine wave continuous average power output per channel, both channels operating into 1 ohm, 2 ohms, 4 ohms, or 8 ohms load impedance, which is:

- 22.4 volts RMS across 1 ohm
- 31.6 volts RMS across 2 ohms
- 44.7 volts RMS across 4 ohms
- 63.2 volts RMS across 8 ohms

MONO: 1000 watts minimum sine wave continuous average power output into 0.5 ohm, 1 ohm, 2 ohms, 4 ohms, 8 ohms, or 16 ohms load impedance, which is:

- 22.4 volts RMS across 0.5 ohm
- 31.6 volts RMS across 1 ohm
- 44.7 volts RMS across 2 ohms
- 63.2 volts RMS across 4 ohms
- 89.4 volts RMS across 8 ohms
- 126.5 volts RMS across 16 ohms

## OUTPUT LOAD IMPEDANCE

STEREO: 1 ohm, 2 ohms, 4 ohms, and 8 ohms; separate terminals are provided for each output.

MONO-PARALLEL: 0.5 ohms, 1 ohm, 2 ohms, and 4 ohms; obtained by connecting in parallel the appropriate terminals of both channels.

MONO-BRIDGED: 2 ohms, 4 ohms, 8 ohms or 16 ohms; obtained by connecting to the output terminals of both channels. The bridged output is balanced to ground. Neither side is grounded.

## RATED POWER BAND

20Hz to 20,000Hz

## TOTAL HARMONIC DISTORTION

STEREO: 0.02% maximum harmonic distortion at any power level from 250 milliwatts to 500 watts per channel from 20Hz to 20,000Hz, both channels operating.

MONO: 0.02% maximum harmonic distortion at any power level from 250 milliwatts to 1000 watts from 20Hz to 20,000Hz.

## INTERMODULATION DISTORTION

STEREO: 0.02% maximum if instantaneous peak power output is 1000 watts or less per channel with both channels operating for any combination of frequencies, 20Hz to 20,000Hz.

MONO: 0.02% maximum if instantaneous peak power output is 2000 watts or less for any combination of frequencies, 20Hz to 20,000Hz.

## FREQUENCY RESPONSE (at one watt output)

- 20Hz to 20,000Hz +0, -0.25dB.
- 10Hz to 100,000Hz +0.25, -1dB.

## NOISE AND HUM

95dB below rated output.

## DAMPING FACTOR

Greater than 30

## INPUT IMPEDANCE

50,000 ohms

## INPUT SENSITIVITY

Switchable: 0.75 or 2.5 volts.  
Level control provided for higher input voltages.

## POWER GUARD

THD not to exceed 2% with up to 20dB overdrive at 1kHz.

## POWER REQUIREMENTS

120 volts, 50/60Hz, 0.7 to 22 amps (15 amps UL/CSA)

## WEIGHT

129 pounds (58.5 kg) net, 144 pounds (65.3 kg) in shipping carton.

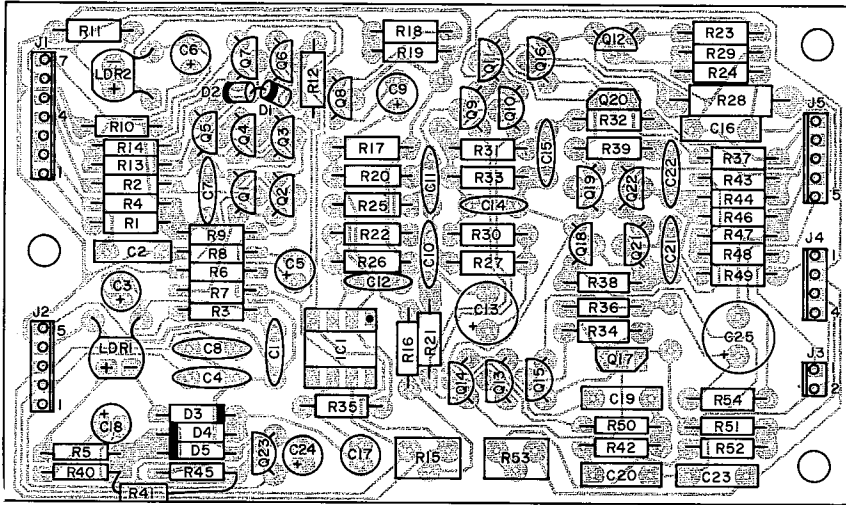

**DRIVER PCB 045928**

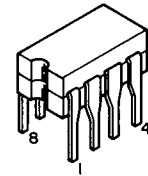

IC1



Q1-Q7, Q9-Q16,  
Q18, Q19, Q21-Q24

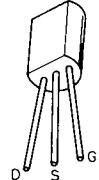

Q8

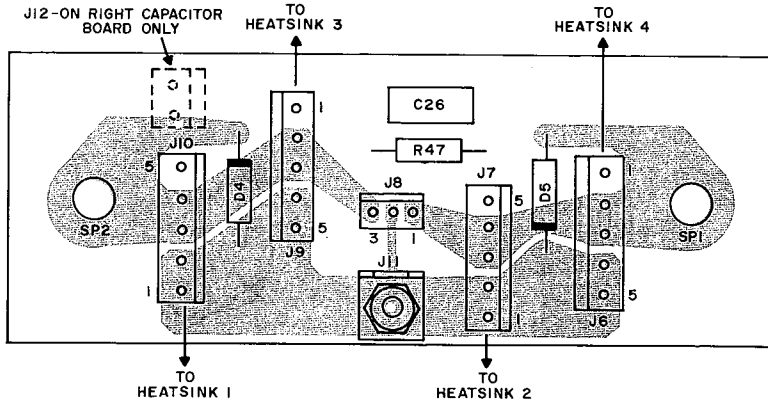

**CAPACITOR BOARDS 045624 (LEFT) AND 045625 (RIGHT)**

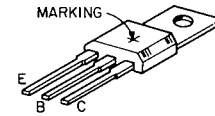

Q17, Q20

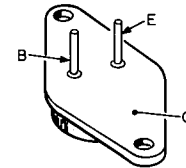

Q25-Q38

## AMPLIFIER PARTS LIST

Symbol	Part	Description			
<b>DIODES</b>					
D1-D5	070047	SIG, 75V, 150mA, 1N4148			
D6, D7	070031	RECT, 400V, 1.5A			
<b>INTEGRATED CIRCUIT</b>					
IC1	133066	Operational Amp NE5534N			
<b>LIGHT DEPENDENT RESISTORS</b>					
LDR1, LDR2	144179	LDR, VTL5C9			
<b>TRANSISTORS</b>					
Q1, Q2	132056	PNP, 2N5087			
Q3, Q4	132223	NPN, MPS4124			
Q5	132185	NPN, Selected 2N6429A			
Q6	132171	NPN, MPSA05			
Q7	132172	PNP, MPSA55			
Q8	132222	N, FET, J108			
Q9-Q11	132185	NPN, Selected 2N6429A			
Q12	132223	NPN, MPS4124			
Q13, Q14	132056	PNP, 2N5087			
Q15	132224	PNP, MPS4126			
Q16	132223	NPN, MPS4124			
Q17	132194	PNP, Selected 2N6556			
Q18	132224	PNP, MPS4126			
Q19	132223	NPN, MPS4124			
Q20	132196	NPN, Selected 2N6553			
Q21	132223	NPN, MPS4124			
Q22	132224	PNP, MPS4126			
Q23	132223	NPN, MPS4124			
Q24	132090	NPN, DAR, MPSA25			
Q25	132197	NPN, Selected MJ3247 (S/N CS1001 thru CS3699)			
	132203	NPN, Selected MJ4248 (S/N CS3700 thru CS3899)			
	132229	NPN, MJ15018 (S/N CS3900 and above)			
Q26	132198	PNP, Selected MJ3237 (S/N CS1001 thru CS3699)			
	132204	PNP, Selected MJ4238 (S/N CS3700 thru CS3899)			
	132230	PNP, MJ15019 (S/N CS3900 and above)			
Q27, Q29	132188	NPN			
Q31, Q33	132188	NPN			
Q35, Q37	132188	NPN			
Q28, Q30	132189	PNP			
Q32, Q34	132189	PNP			
Q36, Q38	132189	PNP			



# Amplifier

Serial No.  
CS4000 and above

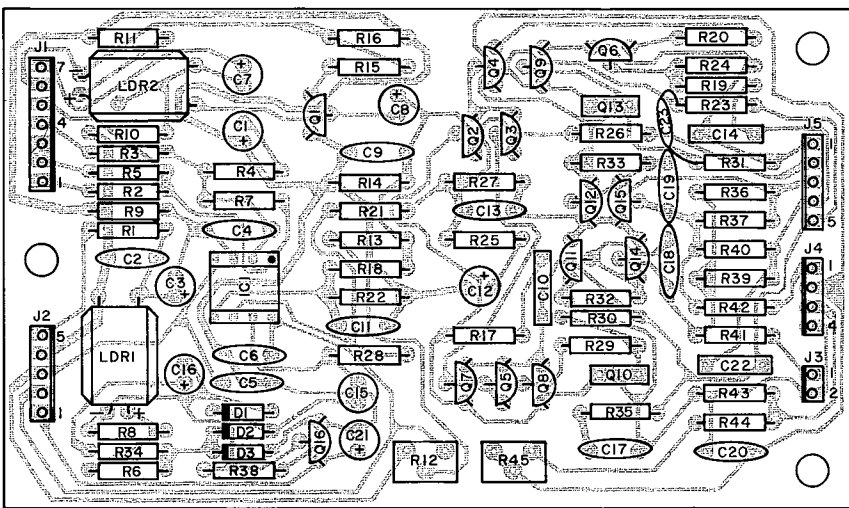

**DRIVER PCB 046783**

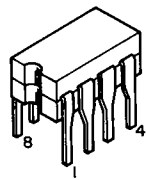

IC1

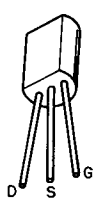

Q1

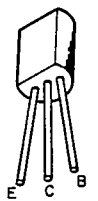

Q2-Q4

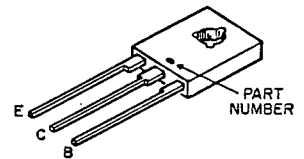

Q10, Q13

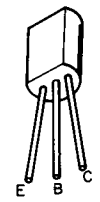

Q5-Q9, Q11, Q12,  
Q14-Q16, Q17

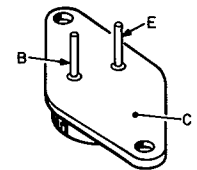

Q18-Q31

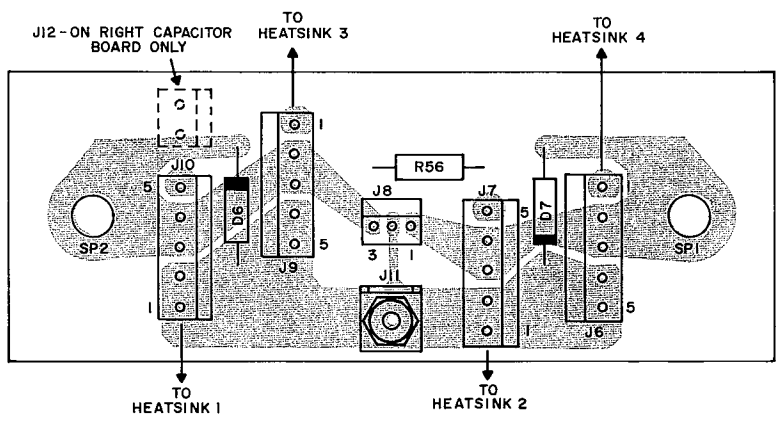

**CAPACITOR BOARDS 045624 (LEFT) AND 045625 (RIGHT)**

## AMPLIFIER PARTS LIST

Symbol	Part	Description
<b>DIODES</b>		
D1-D3	070047	SIG, 75V, 150mA, 1N4148
D4,D5	070031	RECT, 400V, 1.5A
<b>INTEGRATED CIRCUITS</b>		
IC1	133094	Dual Operational Amp, NE5532N
<b>LIGHT DEPENDENT RESISTORS</b>		
LDR1,LDR2	144179	LDR, VTL5C9
<b>TRANSISTORS</b>		
Q1	132193	N, JFET, 2N4392
Q2-Q4	132235	NPN, 2SC2240-BL
Q5	132056	PNP, 2N5087
Q6	132223	NPN, MPS4124
Q7	132056	PNP, 2N5087
Q8	132224	PNP, MPS4126
Q9	132223	NPN, MPS4124
Q10	132234	PNP, 2SA1360
Q11	132224	PNP, MPS4126
Q12	132223	NPN, MPS4124
Q13	132233	NPN, 2SC3423
Q14	132223	NPN, MPS4124
Q15	132224	PNP, MPS4126
Q16	132223	NPN, MPS4124
Q17	132090	NPN, DAR, MPSA25
Q18	132229	NPN, MJ15018
Q19	132230	PNP, MJ15019
Q20, Q22	132188	NPN
Q24, Q26	132188	NPN
Q28, Q30	132188	NPN
Q21, Q23	132189	PNP
Q25, Q27	132189	PNP
Q29, Q31	132189	PNP

# Power Supply and Power Guard Display

4

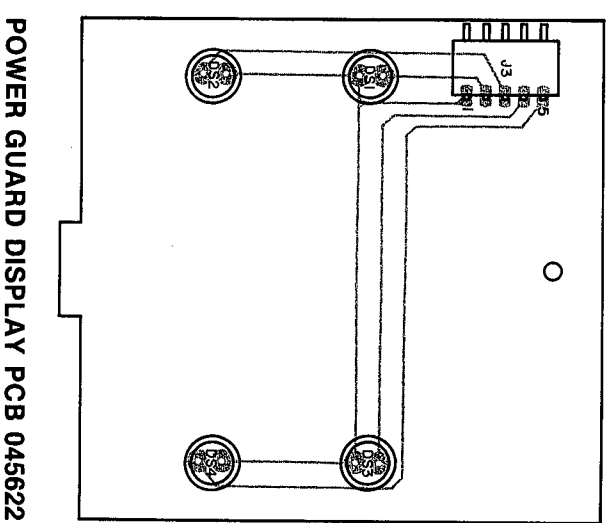
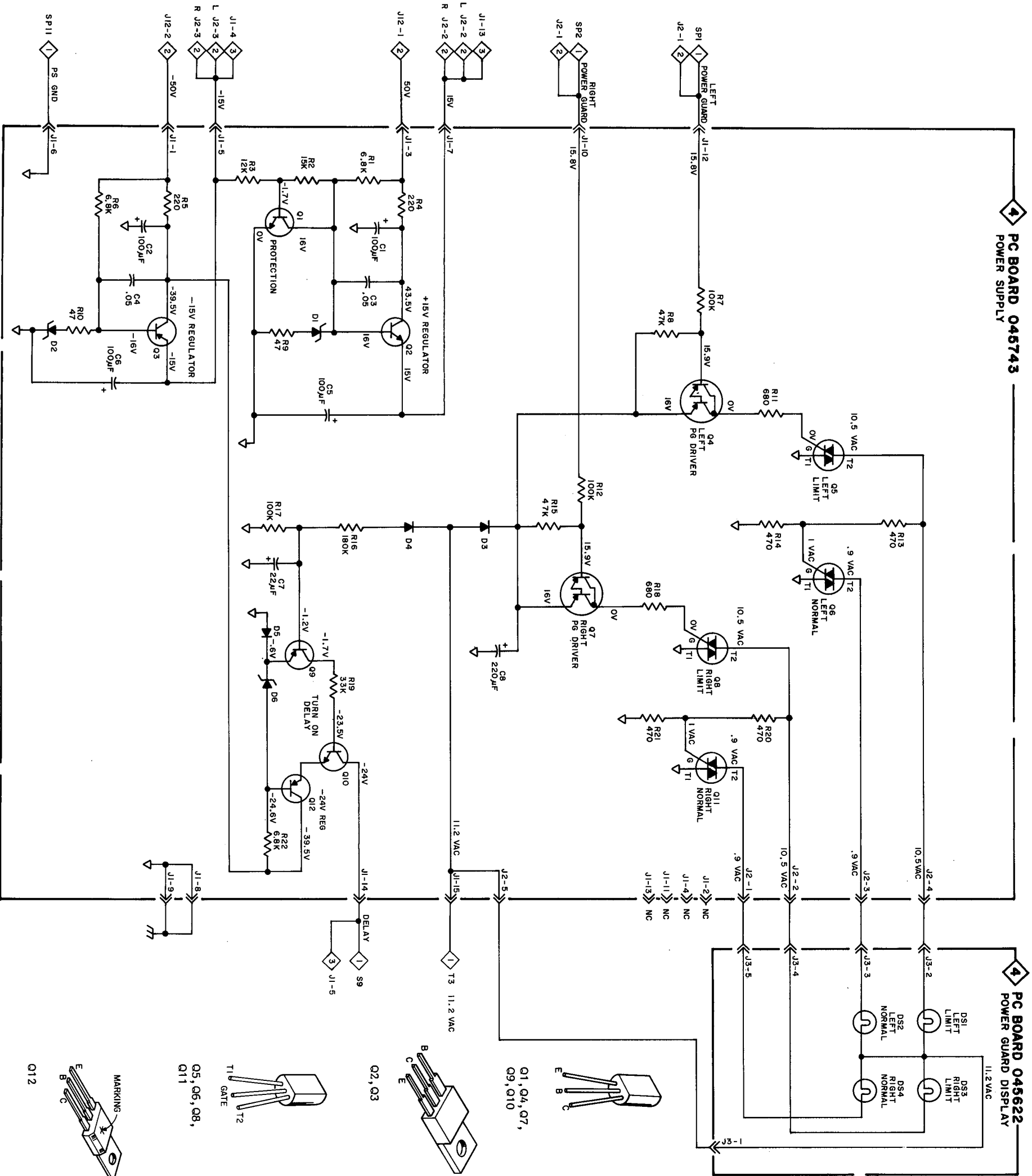

POWER GUARD DISPLAY PCB 045622

## POWER SUPPLY and POWER GUARD DISPLAY PARTS LIST

Symbol	Part	Description
<b>DIODES</b>		
D1, D2	070114	ZN, 16V, 5%, 500mW
D3	070031	RECT, 400V, 1.5A
D4, D5	070047	SIG, 75V, 150mA
D6	070091	ZN, 24V, 5%, 0.5W
<b>LIGHTING DEVICES</b>		
DS1-DS4	058061	INC, 14V, 7382
<b>TRANSISTORS</b>		
Q1	132223	NPN, MPS4124
Q2	132227	NPN, TIP41B
Q3	132228	PNP, TIP42B
Q4	132182	PNP, DAR, MPSA64
Q5, Q6	131011	Triac, MAC91A-1
Q7	132182	PNP, DAR, MPSA64
Q8	131011	Triac, MAC91A-1
Q9	132224	PNP, MPS4126
Q10	132223	NPN, MPS4124
Q11	131011	Triac, MAC91A-1
Q12	132148	PNP, MPSU57

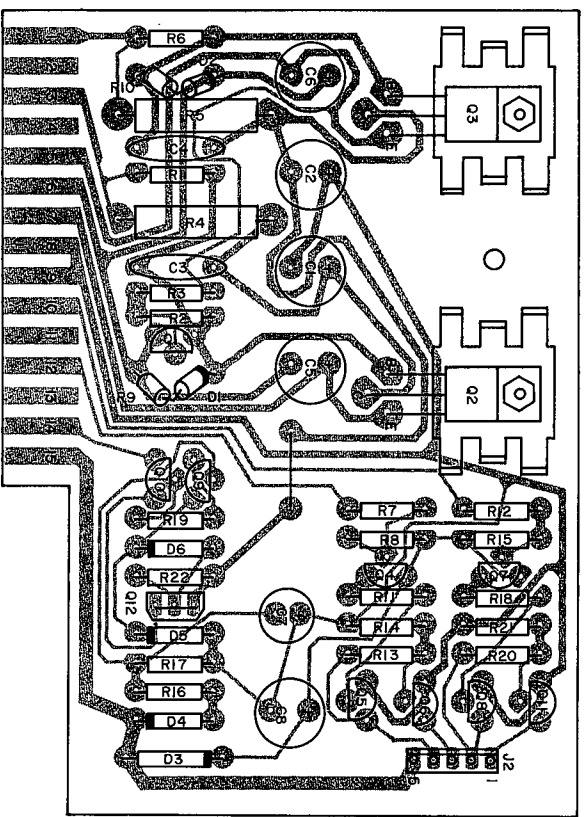

POWER SUPPLY PCB 045743

# Repacking Instructions

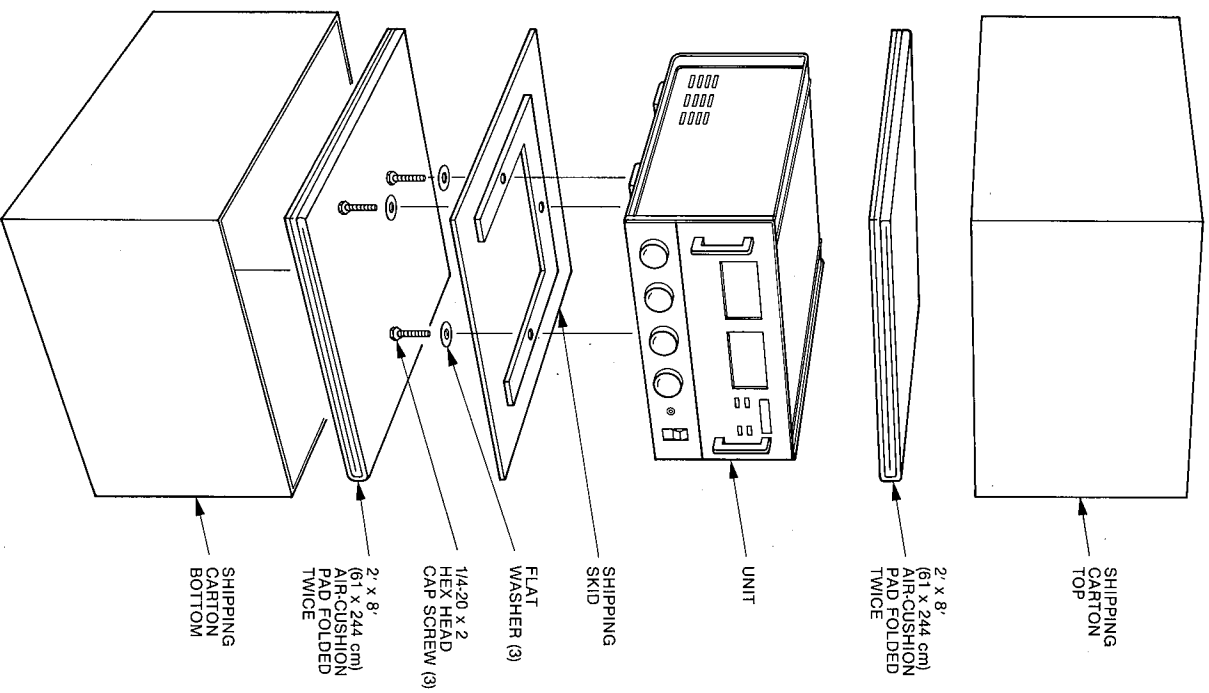

In the event it is necessary to return the MC2500 to McIntosh Laboratory for service, the unit must be packed exactly as shown below.

**IMPORTANT** - The shipping skid must be secured to the unit with the three 1/4-20 x 2" screws, or shipping damage will occur.

If a shipping carton or shipping skid is needed, please call or write Customer Service Department of McIntosh Laboratory. Order using the part numbers on the accompanying list.

Use the original shipping carton only if the carton, skid and pads are in good serviceable condition.

QTY	PART	DESCRIPTION
1	033507	Shipping Carton, Top
1	033474	Shipping Carton, Bottom
1	033090	Shipping Skid
2	033095	2' x 8' Air Cushion Pad
3	101036	1/4-20 x 2" Screw for 033090
3	104058	1-1/2" Flat Washer for 101036
1	045737	Shipping Carton, Complete

## McIntosh® MC2500 STEREO POWER AMPLIFIER

The continuous improvement of its products is the policy of McIntosh Laboratory Incorporated, who reserve the right to improve design without notice. Because of the constant upgrading of McIntosh products' circuitry and components, the Company cannot insure, and does not warrant, the accuracy of the within schematic material, which is intended for information only.

**McIntosh Laboratory Inc. 2 Chambers Street Binghamton, NY 13903-2699**

Part No. 039716

Printed in U.S.A.

Telephone (607)23-3512

# McIntosh

## MC 2500

### Stereo Power Amplifier

# Parts List

For Schematics 039206 and 039257

\*Parts marked with an asterisk (\*) are replacement parts stocked by our Service Department and can be ordered only by part number from McIntosh. Parts not marked can be obtained from electronic parts suppliers.

### Installation Hardware

Symbol No.	Part No.	Name/Description
	*017098	Bumper Feet, Secure w/100062 Screws
	*170015	Dual Coax Cable, 6'
	*170132	AC Power Cord

### Front Panel and Trim

Symbol No.	Part No.	Name/Description
	*003173	Front Panel (Metal Only)
	*017280	Output Terminal Cover
	*018208	Side Rail
	*018187	Handle, 7/16" wide, serial no. CS1148 and below
	*018209	Handle, 3/4" wide, serial no. CS1149 and above
	*074054	Output Terminal Block
	*090106	Knob
	*100061	Machine Screw, 10-32x1/2, Phillips, Blk.
	*100131	Machine Screw, 10-32x1/2, Phillips, Gold
	*101078	Tapping Screw, 8-32x5/16, Phillips, Blk.
	*101088	Tapping Screw, 8-32x1/2, Phillips, Blk.
	*104079	Washer, #8, Black
	*104080	Washer, #10, Gold
	*104083	Washer, #10, Black

### Shipping Carton

Symbol No.	Part No.	Name/Description
	*033293	Shipping Carton only
	*033090	Shipping Skid
	101036	1/4-20x2" Screw (3 required for mounting skid)
	104058	1/4x1 1/2" Flat Washer (3 used with 101036 screws)
	*033095	2'x8' Aircap Pad (2 required)
	*045737	Shipping Carton, Complete

## Section 1 Interconnection Diagram

Symbol No.	Part No.	Name/Description
<b>CAPACITORS</b> (CD = Ceramic Disc, ELECT = Electrolytic, MPE = Metalized Polyester)		
C1	064268	MPE, .068μF, 400V
C2	064268	MPE, .068μF, 400V
C3	064267	MPE, .22μF, 400V
C4	064267	MPE, .22μF, 400V
C5	064267	MPE, .22μF, 400V
C6	064267	MPE, .22μF, 400V
C7	066237	ELECT, 2.2μF, 50V
C8	061175	CD, .005μF, +80 -20%, 150V, UL/CSA
C9	061175	CD, .005μF, +80 -20%, 150V, UL/CSA
<b>CIRCUIT BREAKERS</b> (CB = Circuit Breaker)		
*CB1	088011	CB, 25A, (ON-OFF Switch)
<b>DIODES</b> (BRID = Bridge, RECT = Rectifier)		
*D1	070092	BRID, RECT, 35A, 200V, MDA3502
*D2	070092	BRID, RECT, 35A, 200V, MDA3502

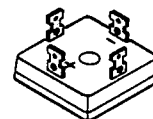

D1, D2

<b>LIGHTING DEVICES</b> (LED = Light Emitting Diode)		
*DS1	058078	LED, Red, SLP144B
*DS2	058077	LED, Green, SLP244B

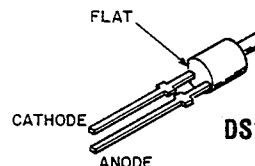

DS1, DS2

<b>METERS</b>		
*M1, M2	124033	Meter, blue front cover, serial no. CS1236 and below. (change 6986)
*M1, M2	124035	Meter, clear front cover, separate blue filter, serial no. CS1237 and above. (change 6986)

<b>RESISTORS</b> (CF = Carbon Film, MF = Metal Film, POT = Potentiometer, WW = Wirewound)		
*R1	134385	POT, Gain Control
*R2	134385	POT, Gain Control
*R3	144113	MF, 100K, 1%, 1/4W
*R4	144113	MF, 100K, 1%, 1/4W
*R5	144148	MF, 31.6K, 1%, 1/4W
*R6	144148	MF, 31.6K, 1%, 1/4W
*R7	139077	WW, 1.8Ω, 10%, 2W
*R8	139077	WW, 1.8Ω, 10%, 2W
R9	139035	WW, 1Ω, 10%, 5W
R10	139035	WW, 1Ω, 10%, 5W
R11	141060	CF, 3.3K, 5%, 1/4W

## Section 1 (continued)

### THERMISTOR

*RT1	144151	Thermistor, 5Ω
*RT2	144151	Thermistor, 5Ω
*RT3	144151	Thermistor, 5Ω
*RT4	144151	Thermistor, 5Ω

### SWITCHES

*S1	146211	Meter Range Switch
*S2	153013	Thermal Switch
*S3	153015	Thermal Switch
*S4	153015	Thermal Switch
*S5	148026	Fan Switch
*S6	153013	Thermal Switch
*S7	146212	Speaker Switch

### TRANSFORMERS

*T1	045648	Output Transformer
*T2	045648	Output Transformer
*T3	045649	Power Transformer

### MISCELLANEOUS

*B1	081001	Fan
*B2	081001	Fan
*	125291	Fan Decal
*J1	117088	Headphone Jack, 3/8"
*F1	174188	#30 Solid Copper Wire, (Fusible Link)

## Section 2 Input Level and Mode Selection

Symbol No.	Part No.	Name/Description
------------	----------	------------------

### CAPACITORS (CD = Ceramic Disc, ELECT = Electrolytic)

C501	061133	CD, 68pF, 10%, N750, CG
C502	066277	ELECT, 3.3μF, 20%, 50V
C503	066277	ELECT, 3.3μF, 20%, 50V
C504	061020	CD, 82pF, 10%, N1500

### RESISTORS (MF = Metal Film)

*R501	144108	MF, 47.5K, 1%, 1/4W
*R502	144106	MF, 33.2K, 1%, 1/4W
*R503	144106	MF, 33.2K, 1%, 1/4W
*R504	144108	MF, 47.5K, 1%, 1/4W

### SWITCHES

*S501	148049	Input Switch
*S502	148054	Mode Switch

## Section 3 Preamp Input and Headphone Output (Left Channel)

Symbol No.	Part No.	Name/Description
------------	----------	------------------

### CAPACITORS (CD = Ceramic Disc, ELECT = Electrolytic)

C201	061016	CD, 33pF, 10%, 500V, NPO
C202	066237	ELECT, 2.2μF, 50V
C203	066313	ELECT, 47μF, 80V, DC
C204	061004	CD, 4.7pF, 20%, 500V, NPO
C205	061161	CD, .047μF, +80 - 20%, 50V
C206	061161	CD, .047μF, +80 - 20%, 50V

### DIODES (Si = Silicon, STAB = Stabistor)

*D201	070046	Si, STAB, 1.3V, 2%, 10mA, Selected MZ236
-------	--------	---

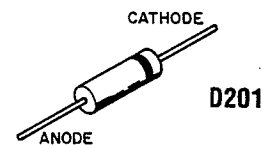

### LIGHT DEPENDENT RESISTORS

*LDR201	144070	LDR, CLM6000
---------	--------	--------------

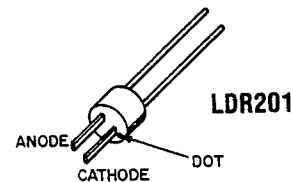

### TRANSISTORS (Si = Silicon)

*Q201	132056	Si, PNP, 2N5087
*Q202	132056	Si, PNP, 2N5087
*Q203	132195	Si, NPN, 40V, Low Noise
*Q204	132195	Si, NPN, 40V, Low Noise
*Q205	132195	Si, NPN, 40V, Low Noise
*Q206	132172	Si, PNP, MPS-A55
*Q207	132171	Si, NPN, MPS-A05

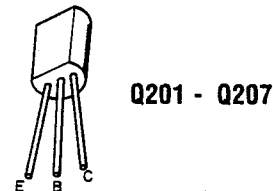

### RESISTORS (CF = Carbon Film, MF = Metal Film)

*R201	144148	MF, 31.6K, 1%, 1/4W
R202	141072	CF, 10K, 5%, 1/4W
R203	141096	CF, 100K, 5%, 1/4W
R204	141096	CF, 100K, 5%, 1/4W
*R205	144083	MF, 5.11K, 2%, 1/4W
*R206	144148	MF, 31.6K, 1%, 1/4W
R207	141064	CF, 4.7K, 5%, 1/4W
R208	141140	CF, 15Ω, 5%, 1/4W
R209	141140	CF, 15Ω, 5%, 1/4W
R210	141029	CF, 150, 5%, 1/4W
R211	141150	CF, 39, 5%, 1/4W



## Section 4 Preamp Input and Headphone Output (Right Channel)

Symbol No.	Part No.	Name/Description
<b>CAPACITORS</b> (CD = Ceramic Disc, ELECT = Electrolytic)		
C301	061016	CD, 33pF, 10%, 500V, NPO
C302	066237	ELECT, 2.2 $\mu$ F, 50V
C303	066313	ELECT, 47 $\mu$ F, 80V, DC
C304	061004	CD, 4.7pF, 20%, 500V, NPO
C305	061161	CD, .047 $\mu$ F, +80 - 20%, 50V
C306	061161	CD, .047 $\mu$ F, +80 - 20%, 50V
<b>DIODES</b> (Si = Silicon, STAB = Stabistor)		
*D301	070046	Si, STAB, 1.3V, 2%, 10mA, Selected MZ236

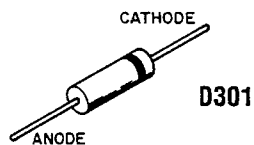

Symbol No.	Part No.	Name/Description
<b>LIGHT DEPENDENT RESISTORS</b>		
*LDR301	144070	LDR, CLM6000

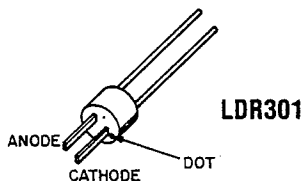

Symbol No.	Part No.	Name/Description
<b>TRANSISTORS</b> (Si = Silicon)		
*Q301	132056	Si, PNP, 2N5087
*Q302	132056	Si, PNP, 2N5087
*Q303	132195	Si, NPN, 40V, Low Noise
*Q304	132195	Si, NPN, 40V, Low Noise
*Q305	132195	Si, NPN, 40V, Low Noise
*Q306	132172	Si, PNP, MPS-A55
*Q307	132171	Si, NPN, MPS-A05

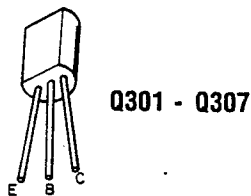

Symbol No.	Part No.	Name/Description
<b>RESISTORS</b> (CF = Carbon Film, MF = Metal Film)		
*R301	144148	MF, 31.6K, 1%, 1/4W
R302	141072	CF, 10K, 5%, 1/4W
R303	141096	CF, 100K, 5%, 1/4W
R304	141096	CF, 100K, 5%, 1/4W
*R305	144083	MF, 5.11K, 2%, 1/4W
*R306	144148	MF, 31.6K, 1%, 1/4W
R307	141064	CF, 4.7K, 5%, 1/4W
R308	141140	CF, 15 $\Omega$ , 5%, 1/4W
R309	141140	CF, 15 $\Omega$ , 5%, 1/4W
R310	141029	CF, 150, 5%, 1/4W
R311	141150	CF, 39, 5%, 1/4W

## Section 5 Power Output Drive and Power Guard (Left Channel)

Symbol No.	Part No.	Name/Description
<b>CAPACITORS</b> (CD = Ceramic Disc, ELECT = Electrolytic, MPE = Metalized Polyester, PF = Polyester Film)		
C401	066241	ELECT, 22 $\mu$ F, 6V
C402	061128	CD, 470pF, 10%, 500V, Z5F
C403	061027	CD, 220pF, 10%, 500V, Z5F
C404	061023	CD, 100pF, 10%, 500V, N1500
C405	066226	ELECT, 100 $\mu$ F, 16V
C406	061023	CD, 100pF, 10%, 500V, N1500
C407	061055	CD, 47pF, 10%, 500V, N470
C408	061029	CD, 330pF, 10%
C409	064169	PF, .0047 $\mu$ F, 5%, 100V
C410	064169	PF, .0047 $\mu$ F, 5%, 100V
C411	061024	CD, 150pF, 10%, 500V, Z5F
C412	061024	CD, 150pF, 10%, 500V, Z5F
C413	064186	MPE, .1 $\mu$ F, 5%, 63V
C414	066215	ELECT, 47 $\mu$ F, 16V
C415	064186	MPE, .1 $\mu$ F, 5%, 63V
C416	061112	CD, 18pF, 10%, 500V, NPO
*C417	066316	ELECT, 10 $\mu$ F, 25V, NP
C418	066244	ELECT, .47 $\mu$ F, 50V
<b>DIODES</b> (Si = Silicon, SIG = Signal)		
*D401	070047	Si, SIG, 75V, 10mA, IN4148
*D402	070047	Si, SIG, 75V, 10mA, IN4148
*D403	070047	Si, SIG, 75V, 10mA, IN4148

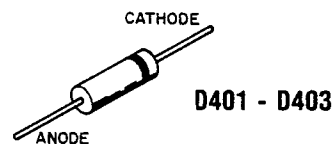

## Section 5 (continued)

### INTEGRATED CIRCUIT (AN = Analog, BP = Bipolar)

\*IC401 133066 AN, BP, Operation Amp,  
NE-5534AN

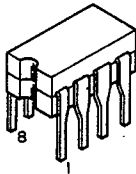

IC401

### LIGHT DEPENDENT RESISTORS

\*LDR401 144159 LDR, CLM6500

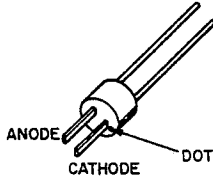

LDR401

### TRANSISTORS (Si = Silicon, N = N Channel, J-FET = Junction FET)

\*Q401 132193 Si, N, J-FET, 2N4392  
\*Q402 132185 Si, NPN, 2N6429A  
\*Q403 132185 Si, NPN, 2N6429A  
\*Q404 132150 Si, PNP, MPS-055  
\*Q405 132150 Si, PNP, MPS-055  
\*Q406 132150 Si, PNP, MPS-055  
\*Q407 132194 Si, NPN  
\*Q408 132150 Si, PNP, MPS-055  
\*Q409 132143 Si, NPN, MPS-D05  
\*Q410 132150 Si, PNP, MPS-055  
\*Q411 132143 Si, NPN, MPS-D05  
\*Q412 132185 Si, NPN, 2N6429A  
\*Q413 132195 Si, NPN, 40V, Low Noise  
\*Q414 132196 Si, NPN  
\*Q415 132195 Si, NPN, 40V, Low Noise

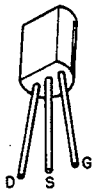

Q401



Q402 - Q406  
Q408 - Q413,  
Q415

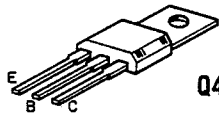

Q407, Q414

### RESISTORS (CF = Carbon Film, POT = Potentiometer, MF = Metal Film, FP = Flameproof)

R401 141057 CF, 2.2K, 5%, 1/4W  
R402 141096 CF, 100K, 5%, 1/4W  
R403 134383 POT, 100K, 20%  
R404 141124 CF, 2.2M, 5%, 1/4W  
R405 141049 CF, 1K, 5%, 1/4W  
R406 141068 CF, 6.8K, 5%, 1/4W  
R407 141049 CF, 1K, 5%, 1/4W  
\*R408 144090 MF, 1K, 1%, 1/4W  
\*R409 144053 MF, 10K, 1%, 1/4W  
\*R410 144053 MF, 10K, 1%, 1/4W

\*R411 144053 MF, 10K, 1%, 1/4W  
R412 141049 CF, 1K, 5%, 1/4W  
\*R413 144158 FP, 15Ω, 5%, 1/4W  
R414 141064 CF, 4.7K, 5%, 1/4W  
R415 141064 CF, 4.7K, 5%, 1/4W  
R416 141062 CF, 3.9K, 5%, 1/4W  
R417 141100 CF, 150K, 5%, 1/4W  
R418 141057 CF, 2.2K, 5%, 1/4W  
R419 141062 CF, 3.9K, 5%, 1/4W  
R420 141100 CF, 150K, 5%, 1/4W  
R421 141057 CF, 2.2K, 5%, 1/4W  
R422 141025 CF, 100, 5%, 1/4W  
R423 141025 CF, 100, 5%, 1/4W  
\*R424 144157 FP, 10Ω, 5%, 1/4W  
R425 141160 CF, 3K, 5%, 1/4W  
R426 141057 CF, 2.2K, 5%, 1/4W  
R427 134384 POT, 2K, 20%  
R428 141196 CF, 47K, 5%, 1/2W  
R429 141037 CF, 330, 5%, 1/4W  
R430 141150 CF, 39, 5%, 1/4W  
R431 141086 CF, 39K, 5%, 1/4W  
R432 141068 CF, 6.8K, 5%, 1/4W  
R433 141102 CF, 180K, 5%, 1/4W  
R434 141120 CF, 1M, 5%, 1/4W  
R435 141064 CF, 4.7K, 5%, 1/4W

## Section 6



## Power Output Drive and Power Guard (Right Channel)

Symbol Part  
No. No. Name/Description

**CAPACITORS** (CD = Ceramic Disc,  
ELECT = Electrolytic,  
MPE = Metalized Polyester, PF = Polyester Film)

C101 066241 ELECT, 22μF, 6V  
C102 061128 CD, 470pF, 10%, 500V, Z5F  
C103 061027 CD, 220pF, 10%, 500V, Z5F  
C104 061023 CD, 100pF, 10%, 500V,  
N1500  
C105 066226 ELECT, 100μF, 16V  
C106 061023 CD, 100pF, 10%, 500V,  
N1500  
C107 061055 CD, 47pF, 10%, 500V, N470  
C108 061029 CD, 330pF, 10%  
C109 064169 PF, .0047μF, 5%, 100V  
C110 064169 PF, .0047μF, 5%, 100V  
C111 061024 CD, 150pF, 10%, 500V, Z5F  
C112 061024 CD, 150pF, 10%, 500V, Z5F  
C113 064186 MPE, .1μF, 5%, 63V

C114	066215	ELECT, 47 $\mu$ F, 16V
C115	064186	MPE, .1 $\mu$ F, 5%, 63V
C116	061112	CD, 18pF, 10%, 500V, NPO
*C117	066316	ELECT, 10 $\mu$ F, 25V, NP
C118	066244	ELECT, .47 $\mu$ F, 50V

**DIODES** (Si = Silicon, SIG = Signal)

*D101	070047	Si, SIG, 75V, 10mA, IN4148
*D102	070047	Si, SIG, 75V, 10mA, IN4148
*D103	070047	Si, SIG, 75V, 10mA, IN4148

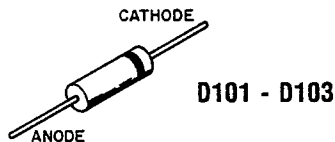

**INTEGRATED CIRCUIT** (AN = Analog, BP = Bipolar)

*IC101	133066	AN, BP, Operation Amp, NE-5534AN
--------	--------	----------------------------------

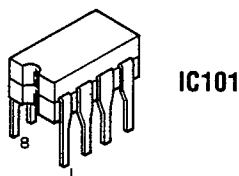

**LIGHT DEPENDENT RESISTORS**

*LDR101	144159	LDR, CLM6500
---------	--------	--------------

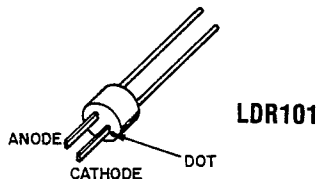

**TRANSISTORS** (Si = Silicon, N = N Channel, J-FET = Junction FET)

*Q101	132193	Si, N, J-FET, 2N4392
*Q102	132185	Si, NPN, 2N6429A
*Q103	132185	Si, NPN, 2N6429A
*Q104	132150	Si, PNP, MPS-055
*Q105	132150	Si, PNP, MPS-055
*Q106	132150	Si, PNP, MPS-055
*Q107	132194	Si, NPN
*Q108	132150	Si, PNP, MPS-055
*Q109	132143	Si, NPN, MPS-D05
*Q110	132150	Si, PNP, MPS-055
*Q111	132143	Si, NPN, MPS-D05
*Q112	132185	Si, NPN, 2N6429A
*Q113	132195	Si, NPN, 40V, Low Noise
*Q114	132196	Si, NPN
*Q115	132195	Si, NPN, 40V, Low Noise

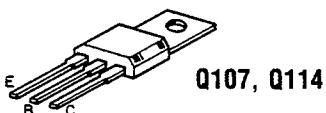

**RESISTORS** (CF = Carbon Film, POT = Potentiometer, MF = Metal Film, FP = Flameproof)

R101	141057	CF, 2.2K, 5%, 1/4W
R102	141096	CF, 100K, 5%, 1/4W
R103	134383	POT, 100K, 20%
R104	141124	CF, 2.2M, 5%, 1/4W
R105	141049	CF, 1K, 5%, 1/4W
R106	141068	CF, 6.8K, 5%, 1/4W
R107	141049	CF, 1K, 5%, 1/4W
*R108	144090	MF, 1K, 1%, 1/4W
*R109	144053	MF, 10K, 1%, 1/4W
*R110	144053	MF, 10K, 1%, 1/4W
*R111	144053	MF, 10K, 1%, 1/4W
R112	141049	CF, 1K, 5%, 1/4W
*R113	144158	FP, 15 $\Omega$ , 5%, 1/4W
R114	141064	CF, 4.7K, 5%, 1/4W
R115	141064	CF, 4.7K, 5%, 1/4W
R116	141062	CF, 3.9K, 5%, 1/4W
R117	141100	CF, 150K, 5%, 1/4W
R118	141057	CF, 2.2K, 5%, 1/4W
R119	141062	CF, 3.9K, 5%, 1/4W
R120	141100	CF, 150K, 5%, 1/4W
R121	141057	CF, 2.2K, 5%, 1/4W
R122	141025	CF, 100, 5%, 1/4W
R123	141025	CF, 100, 5%, 1/4W
*R124	144157	FP, 10 $\Omega$ , 5%, 1/4W
R125	141160	CF, 3K, 5%, 1/4W
R126	141057	CF, 2.2K, 5%, 1/4W
R127	134384	POT, 2K, 20%
R128	141196	CF, 47K, 5%, 1/2W
R129	141037	CF, 330, 5%, 1/4W
R130	141150	CF, 39, 5%, 1/4W
R131	141086	CF, 39K, 5%, 1/4W
R132	141068	CF, 6.8K, 5%, 1/4W
R133	141102	CF, 180K, 5%, 1/4W
R134	141120	CF, 1M, 5%, 1/4W
R135	141064	CF, 4.7K, 5%, 1/4W

# Section



## Power Output (Left Channel)

Symbol Part  
No. No. Name/Description

**CAPACITORS** (CD = Ceramic Disc,  
ELECT = Electrolytic,  
MPE = Metalized Polyester)

- C701 064190 MPE, .22 $\mu$ F, 5%, 63V
- \*C702 066331 ELECT, 38,000 $\mu$ F, 60V
- \*C703 066331 ELECT, 38,000 $\mu$ F, 60V
- C704 061029 CD, 330pF, 10%

**DIODES** (RECT = Rectifier, Si = Silicon)

- \*D701 070031 Si, RECT, 400 PIV, 1.5A
- \*D702 070031 Si, RECT, 400 PIV, 1.5A

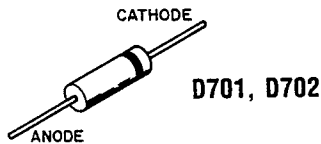

- \*R710 139125 WW, .15 $\Omega$ , 5%, 5W, Noninductive
- \*R711 139125 WW, .15 $\Omega$ , 5%, 5W, Noninductive
- \*R712 139125 WW, .15 $\Omega$ , 5%, 5W, Noninductive
- \*R713 139125 WW, .15 $\Omega$ , 5%, 5W, Noninductive

**TRANSISTORS** (DAR = Darlington, Si = Silicon)

- \*Q701 132197 Si, NPN, Selected MJ3247
- \*Q702 132188 Si, NPN, MJ15003
- \*Q703 132188 Si, NPN, MJ15003
- \*Q704 132188 Si, NPN, MJ15003
- \*Q705 132188 Si, NPN, MJ15003
- \*Q706 132188 Si, NPN, MJ15003
- \*Q707 132188 Si, NPN, MJ15003
- \*Q708 132090 Si, NPN, DAR, Selected MPS-A14
- \*Q709 132198 Si, PNP, Selected MJ3237
- \*Q710 132189 Si, PNP, MJ15004
- \*Q711 132189 Si, PNP, MJ15004
- \*Q712 132189 Si, PNP, MJ15004
- \*Q713 132189 Si, PNP, MJ15004
- \*Q714 132189 Si, PNP, MJ15004
- \*Q715 132189 Si, PNP, MJ15004

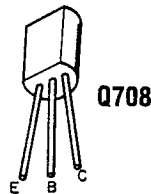
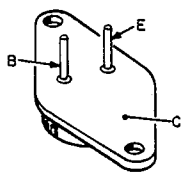

# Section 8 Power Output (Right Channel)

Symbol Part  
No. No. Name/Description

**CAPACITORS** (CD = Ceramic Disc,  
ELECT = Electrolytic,  
MPE = Metalized Polyester)

- C901 064190 MPE, .22 $\mu$ F, 5%, 63V
- \*C902 066331 ELECT, 38,000 $\mu$ F, 60V
- \*C903 066331 ELECT, 38,000 $\mu$ F, 60V
- C904 061029 CD, 330pF, 10%

**DIODES** (RECT = Rectifier, Si = Silicon)

- \*D901 070031 Si, RECT, 400 PIV, 1.5A
- \*D902 070031 Si, RECT, 400 PIV, 1.5A

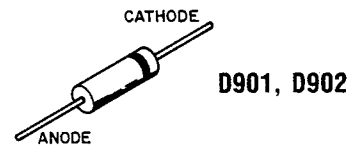

**RESISTORS** (FP = Flameproof, WW = Wirewound)

- \*R701 139125 WW, .15 $\Omega$ , 5%, 5W, Noninductive
- \*R702 139125 WW, .15 $\Omega$ , 5%, 5W, Noninductive
- \*R703 139125 WW, .15 $\Omega$ , 5%, 5W, Noninductive
- \*R704 139125 WW, .15 $\Omega$ , 5%, 5W, Noninductive
- \*R705 139125 WW, .15 $\Omega$ , 5%, 5W, Noninductive
- \*R706 139125 WW, .15 $\Omega$ , 5%, 5W, Noninductive
- \*R707 144066 FP, 22 $\Omega$ , 10%, 1/2W
- \*R708 139125 WW, .15 $\Omega$ , 5%, 5W, Noninductive
- \*R709 139125 WW, .15 $\Omega$ , 5%, 5W, Noninductive

**TRANSISTORS** (DAR = Darlington, Si = Silicon)

- \*Q901 132197 Si, NPN, Selected MJ3247
- \*Q902 132188 Si, NPN, MJ15003
- \*Q903 132188 Si, NPN, MJ15003
- \*Q904 132188 Si, NPN, MJ15003
- \*Q905 132188 Si, NPN, MJ15003
- \*Q906 132188 Si, NPN, MJ15003
- \*Q907 132188 Si, NPN, MJ15003
- \*Q908 132090 Si, NPN, DAR, Selected MPS-A14
- \*Q909 132198 Si, PNP, Selected MJ3237
- \*Q910 132189 Si, PNP, MJ15004
- \*Q911 132189 Si, PNP, MJ15004
- \*Q912 132189 Si, PNP, MJ15004
- \*Q913 132189 Si, PNP, MJ15004
- \*Q914 132189 Si, PNP, MJ15004
- \*Q915 132189 Si, PNP, MJ15004

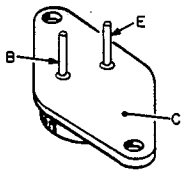

Q901 - Q907  
Q909 - Q915

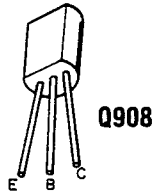

Q908

**RESISTORS** (FP = Flameproof, WW = Wirewound)

*R901	139125	WW, .15Ω, 5%, 5W, Noninductive
*R902	139125	WW, .15Ω, 5%, 5W, Noninductive
*R903	139125	WW, .15Ω, 5%, 5W, Noninductive
*R904	139125	WW, .15Ω, 5%, 5W, Noninductive
*R905	139125	WW, .15Ω, 5%, 5W, Noninductive
*R906	139125	WW, .15Ω, 5%, 5W, Noninductive
*R907	144066	FP, 22Ω, 10%, 1/2W
*R908	139125	WW, .15Ω, 5%, 5W, Noninductive
*R909	139125	WW, .15Ω, 5%, 5W, Noninductive
*R910	139125	WW, .15Ω, 5%, 5W, Noninductive
*R911	139125	WW, .15Ω, 5%, 5W, Noninductive
*R912	139125	WW, .15Ω, 5%, 5W, Noninductive
*R913	139125	WW, .15Ω, 5%, 5W, Noninductive

C607	061002	CD, 1.8pF, ±.25pF, NPO
C608	061002	CD, 1.8pF, ±.25pF, NPO
C609	064143	MPE, 1.5μF, 100V
C610	064143	MPE, 1.5μF, 100V
C611	061035	CD, .001μF, 20%, 500V, Z5U
C612	061035	CD, .001μF, 20%, 500V, Z5U
C613	066290	ELECT, 6.8μF, 10%, 25V
C614	066290	ELECT, 6.8μF, 10%, 25V
C615	066211	ELECT, 10μF, 16V
C616	066226	ELECT, 100μF, 16V
C617	066211	ELECT, 10μF, 16V

**DIODES** (SIG = Signal, Si = Silicon)

*D601	070047	Si, SIG, 75V, 10mA, IN4148
*D602	070047	Si, SIG, 75V, 10mA, IN4148
*D603	070047	Si, SIG, 75V, 10mA, IN4148
*D604	070047	Si, SIG, 75V, 10mA, IN4148
*D605	070047	Si, SIG, 75V, 10mA, IN4148
*D606	070047	Si, SIG, 75V, 10mA, IN4148
*D607	070047	Si, SIG, 75V, 10mA, IN4148
*D608	070047	Si, SIG, 75V, 10mA, IN4148
*D609	070047	Si, SIG, 75V, 10mA, IN4148
*D610	070047	Si, SIG, 75V, 10mA, IN4148
*D611	070047	Si, SIG, 75V, 10mA, IN4148
*D612	070047	Si, SIG, 75V, 10mA, IN4148
*D613	070047	Si, SIG, 75V, 10mA, IN4148

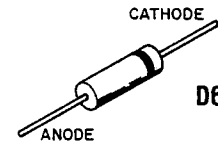

D601 - D613

**LIGHTING DEVICES** (INC = Incandescent)

*DS601	058055	INC, 6.3V, 250mA, GE259
*DS602	058055	INC, 6.3V, 250mA, GE259
*DS603	058055	INC, 6.3V, 250mA, GE259
*DS604	058055	INC, 6.3V, 250mA, GE259
*DS605	058055	INC, 6.3V, 250mA, GE259
*DS606	058055	INC, 6.3V, 250mA, GE259
*DS607	058055	INC, 6.3V, 250mA, GE259
*DS608	058055	INC, 6.3V, 250mA, GE259

**INTEGRATED CIRCUITS** (AN = Analog, BP = Bipolar)

*IC601	133068	AN, BP, Operation Amp, LM201A
*IC602	133068	AN, BP, Operation Amp, LM201A
*IC603	133068	AN, BP, Operation Amp, LM201A
*IC604	133068	AN, BP, Operation Amp, LM201A

**Section 9 Meter Drive and Illumination**

Symbol No.	Part No.	Name/Description
------------	----------	------------------

**CAPACITORS** (CD = Ceramic Disc,  
ELECT = Electrolytic,  
MPE = Metalized Polyester)

C601	066215	ELECT, 47μF, 16V
C602	066215	ELECT, 47μF, 16V
*C603	066316	ELECT, 10μF, 25V, NP
*C604	066316	ELECT, 10μF, 25V, NP
C605	061016	CD, 33pF, 10%, 500V, NPO
C606	061016	CD, 33pF, 10%, 500V, NPO

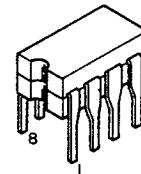

IC601 - IC604

## Section 9 (continued)

### TRANSISTORS (Si = Silicon)

*Q601	132195	Si, NPN, 40V, Low Noise
*Q602	132195	Si, NPN, 40V, Low Noise
*Q603	132056	Si, PNP, 2N5087
*Q604	132056	Si, PNP, 2N5087
*Q605	132143	Si, NPN, MPS-D05
*Q606	132150	Si, PNP, MPS-055



Q601 - Q606

### RESISTORS (CC = Carbon Composition, CF = Carbon Film, MF = Metal Film, POT = Potentiometer)

R601	141057	CF, 2.2K, 5%, 1/4W
R602	141057	CF, 2.2K, 5%, 1/4W
*R603	144149	MF, 14.7K, 1%, 1/4W
*R604	144149	MF, 14.7K, 1%, 1/4W
R605	141092	CF, 68K, 5%, 1/4W
R606	141092	CF, 68K, 5%, 1/4W
*R607	134387	POT, 5K, 20%
*R608	134387	POT, 5K, 20%
R609	141057	CF, 2.2K, 5%, 1/4W
R610	141057	CF, 2.2K, 5%, 1/4W
R611	141072	CF, 10K, 5%, 1/4W
R612	141072	CF, 10K, 5%, 1/4W
R613	141072	CF, 10K, 5%, 1/4W
R614	141072	CF, 10K, 5%, 1/4W
R615	141072	CF, 10K, 5%, 1/4W
R616	141072	CF, 10K, 5%, 1/4W
R617	141124	CF, 2.2M, 5%, 1/4W
R618	141124	CF, 2.2M, 5%, 1/4W
R619	141108	CF, 330K, 5%, 1/4W
R620	141108	CF, 330K, 5%, 1/4W
R621	141102	CF, 180K, 5%, 1/4W
R622	141102	CF, 180K, 5%, 1/4W
R623	141124	CF, 2.2M, 5%, 1/4W
R624	141124	CF, 2.2M, 5%, 1/4W
R625	141152	CF, 47, 5%, 1/4W
R626	141152	CF, 47, 5%, 1/4W
*R627	134383	POT, 100K, 20%
*R628	134383	POT, 100K, 20%
R629	141072	CF, 10K, 5%, 1/4W
R630	141072	CF, 10K, 5%, 1/4W
R631	141062	CF, 3.9K, 5%, 1/4W
R632	141062	CF, 3.9K, 5%, 1/4W
R633	141080	CF, 22K, 5%, 1/4W
R634	141072	CF, 10K, 5%, 1/4W
R635	141092	CF, 68K, 5%, 1/4W
R636	136477	CC, 22M, 10%, 1/4W
R637	136477	CC, 22M, 10%, 1/4W

## Section 10 Power Supply and Power Guard Display Drive

Symbol No.	Part No.	Name/Description
------------	----------	------------------

### CAPACITORS (CD = Ceramic Disc, ELECT = Electrolytic)

C801	066329	ELECT, 100 $\mu$ F, 35V
C802	061043	CD, .01 $\mu$ F, +80 -20%
C803	066329	ELECT, 100 $\mu$ F, 35V
C804	066329	ELECT, 100 $\mu$ F, 35V
C805	061043	CD, .01 $\mu$ F, +80 -20%
C806	066329	ELECT, 100 $\mu$ F, 35V
C807	066330	ELECT, 220 $\mu$ F, 16V
C808	066214	ELECT, 22 $\mu$ F, 35V

### DIODES (RECT = Rectifier, SIG = Signal, ZN = Zener, Si = Silicon)

*D801	070114	Si, ZN, 16V, 5%, 500mW
*D802	070114	Si, ZN, 16V, 5%, 500mW
*D803	070031	Si, RECT, 400 PIV, 1.5A
*D804	070047	Si, SIG, 75V, 10mA, IN4148
*D805	070047	Si, SIG, 75V, 10mA, IN4148
*D806	070091	Si, ZN, 24V, 5%, 0.5W

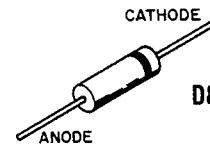

D801 - D806

### LIGHTING DEVICES (INC = Incandescent)

*DS801	058061	INC, 14V, 80mA, JKL7382
*DS802	058061	INC, 14V, 80mA, JKL7382
*DS803	058061	INC, 14V, 80mA, JKL7382
*DS804	058061	INC, 14V, 80mA, JKL7382

### TRANSISTORS (DAR = Darlington, Si = Silicon)

*Q801	132182	Si, PNP, DAR, MPS-A64
*Q802	131011	Si, Triac, IB200-1
*Q803	131011	Si, Triac, IB200-1
*Q804	132182	Si, PNP, DAR, MPS-A64
*Q805	131011	Si, Triac, IB200-1
*Q806	131011	Si, Triac, IB200-1
*Q807	132174	Si, NPN, FT3055
*Q808	132143	Si, NPN, MPS-D05
*Q809	132173	Si, PNP, FT2955
*Q810	132147	Si, PNP, MPS-A93
*Q811	132143	Si, NPN, MPS-D05
*Q812	132148	Si, PNP, MPS-U57



Q801, Q804  
Q808, Q810  
Q811

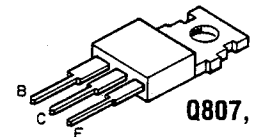

Q807, Q809

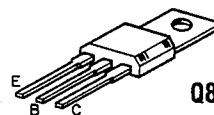

Q812

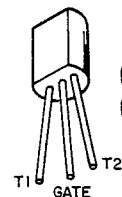

Q802, Q803  
Q805, Q806

**RESISTORS** (CF = Carbon Film, FP = Flameproof)

R801	141096	CF, 100K, 5%, 1/4W
R802	141088	CF, 47K, 5%, 1/4W
R803	141045	CF, 680, 5%, 1/4W
R804	141041	CF, 470, 5%, 1/4W
R805	141041	CF, 470, 5%, 1/4W
R806	141041	CF, 470, 5%, 1/4W
R807	141041	CF, 470, 5%, 1/4W
R808	141045	CF, 680, 5%, 1/4W
R809	141096	CF, 100K, 5%, 1/4W
R810	141088	CF, 47K, 5%, 1/4W
R811	141102	CF, 180K, 5%, 1/4W
R812	141096	CF, 100K, 5%, 1/4W
R813	141084	CF, 33K, 5%, 1/4W
R814	141068	CF, 6.8K, 5%, 1/4W
*R815	139158	FP, 220 $\Omega$ , 10%, 2W
R816	141068	CF, 6.8K, 5%, 1/4W
R817	141076	CF, 15K, 5%, 1/4W
R818	141074	CF, 12K, 5%, 1/4W
*R819	139158	FP, 220 $\Omega$ , 10%, 2W
R820	141068	CF, 6.8K, 5%, 1/4W

The continuous improvement of its products is the policy of McIntosh Laboratory Incorporated, who reserve the right to improve design without notice. Because of the constant upgrading of McIntosh products' circuitry and components, the Company cannot insure, and does not warrant, the accuracy of this parts list, which is intended for information only.

**McIntosh Laboratory Inc. 2 Chambers Street, Binghamton, NY 13903-9990**





AREA CODE 607 723-3512

*McINTOSH LABORATORY INC.*

2 CHAMBERS STREET  
BINGHAMTON, N. Y. 13903

MC2500 SCHEMATICS

These schematics are updated to include all circuit changes made to the MC2500 from the first unit to present production.

A layout of PC boards and heatsinks is included to identify schematic part locations, along with complete parts list for each section.

These schematics supersede and make obsolete any other schematic and parts list for the MC2500.

McINTOSH LABORATORY INC.  
Service Publications Dept.

